

# Data Sheet

PRELIMINARY

## L690D-66-60-110

Infrared illuminator

USHIO

### Outline and Internal Circuit

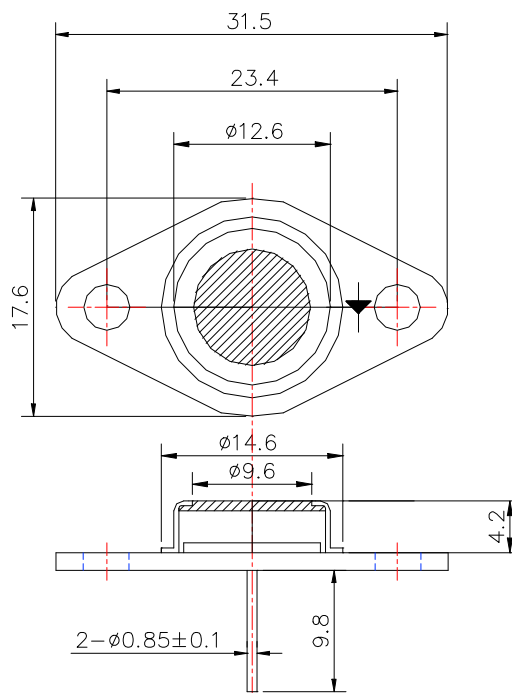

(Unit : mm)

### Features

- Chip Material : AlGaInP
- Chip Dimension : 350um \* 350um
- Number of Chips : 60pcs
- Peak Wavelength : 690nm typ.
- Stem : TO-66 stem
- Lens : Flat Glass Cap

### Application

## Absolute Maximum Ratings (Tc=25°C)

Item	Symbol	Ratings	Unit
Power Dissipation	PD	7.2	W
Forward Current	IF	600	mA
Reverse Voltage	VR	25	V
Thermal Resistance	Rthja	2	K/W
Junction Temperature	Tj	120	°C
Operating Temperature	Topr	-40 ~ +85	°C
Storage Temperature	Tstg	-40 ~ +100	°C
Soldering Temperature	TSOL	265	°C

‡Soldering condition: Soldering condition must be completed with 3 seconds at 265°C.

## Optical and Electrical Characteristics (Tc=25°C)

Parameter	Symbol	Min	Typ	Max	Unit	Test Condition
Forward Voltage	VF		9.5	12	V	IF=240mA
Total Radiated Power	PO		400		mW	IF=240mA
Peak Wavelength	$\lambda_p$	680		700	nm	IF=240mA
Half Width	$\Delta\lambda$		16		nm	IF=240mA
Viewing Half Angle	$\theta_{1/2}$		±53		deg.	IF=100mA
Rise Time	tr		40		ns	IF=240mA
Fall Time	tf		30		ns	IF=240mA

‡ Radiated Power is measured by S3584-08.

## Typical Characteristic Curves

### Forward Current - Forward Voltage

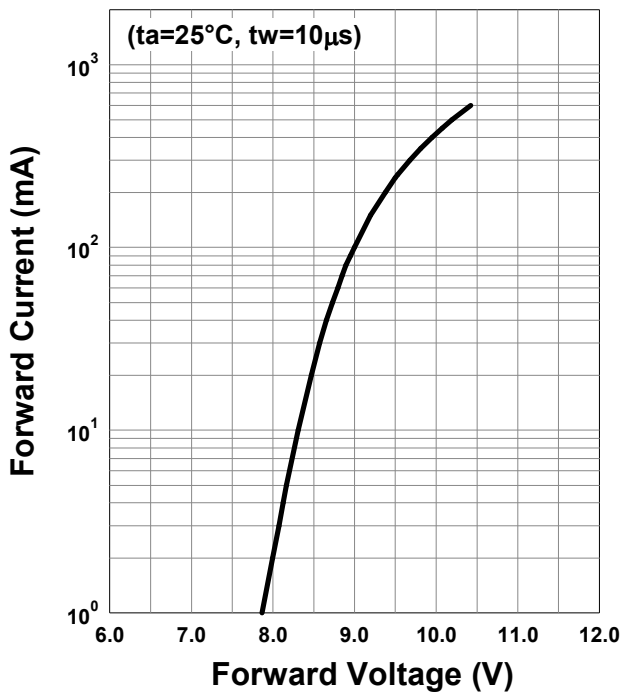

### Relative Radiant Intensity - Forward Current

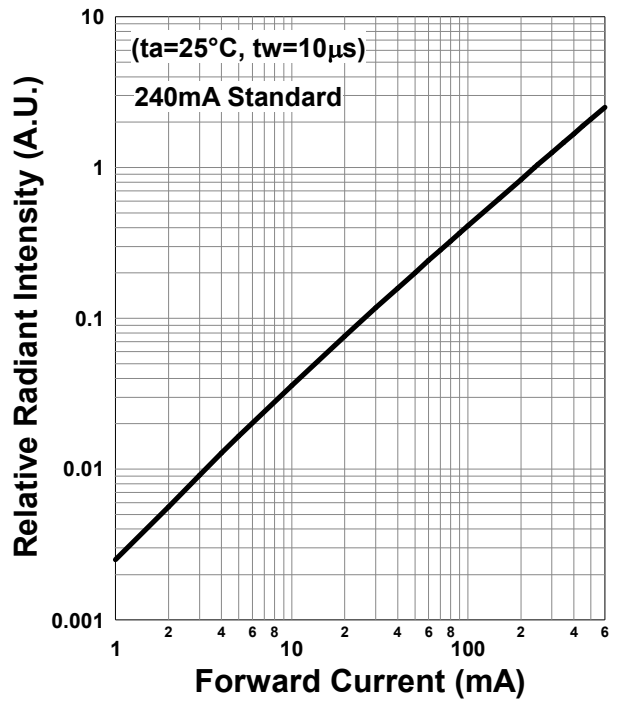

### Allowable Forward Current - Ambient Temperature

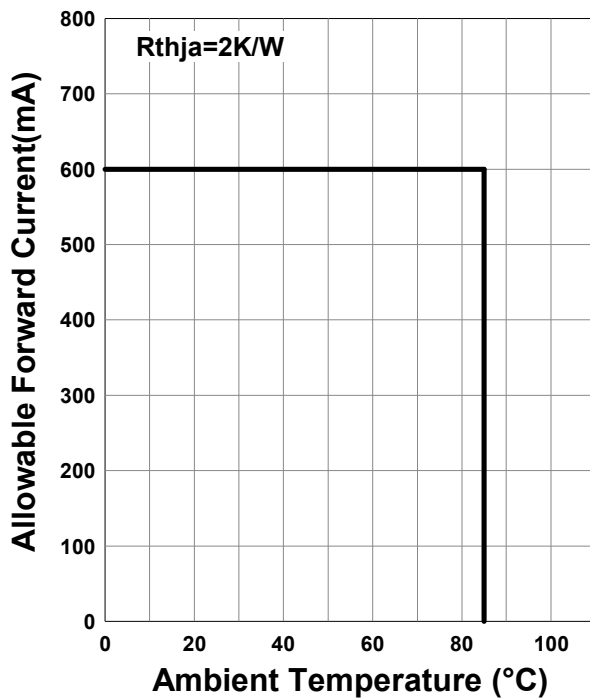

**Radiation Characteristics**

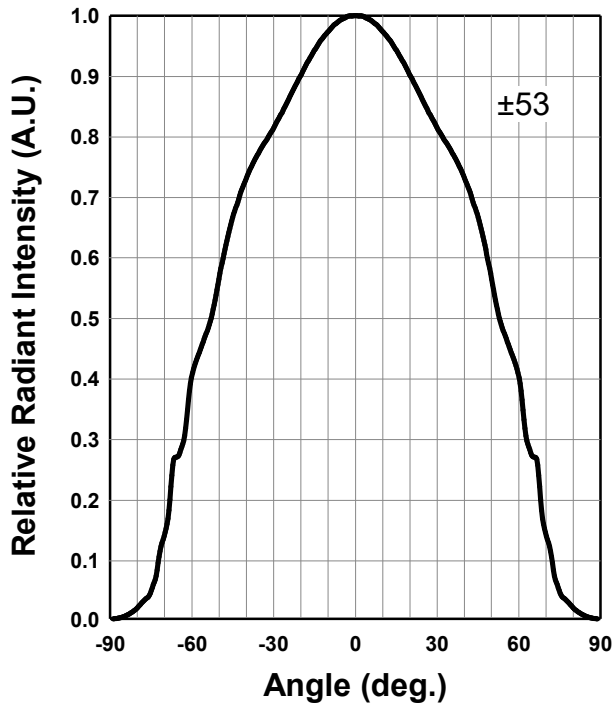

**Radiation Characteristics**

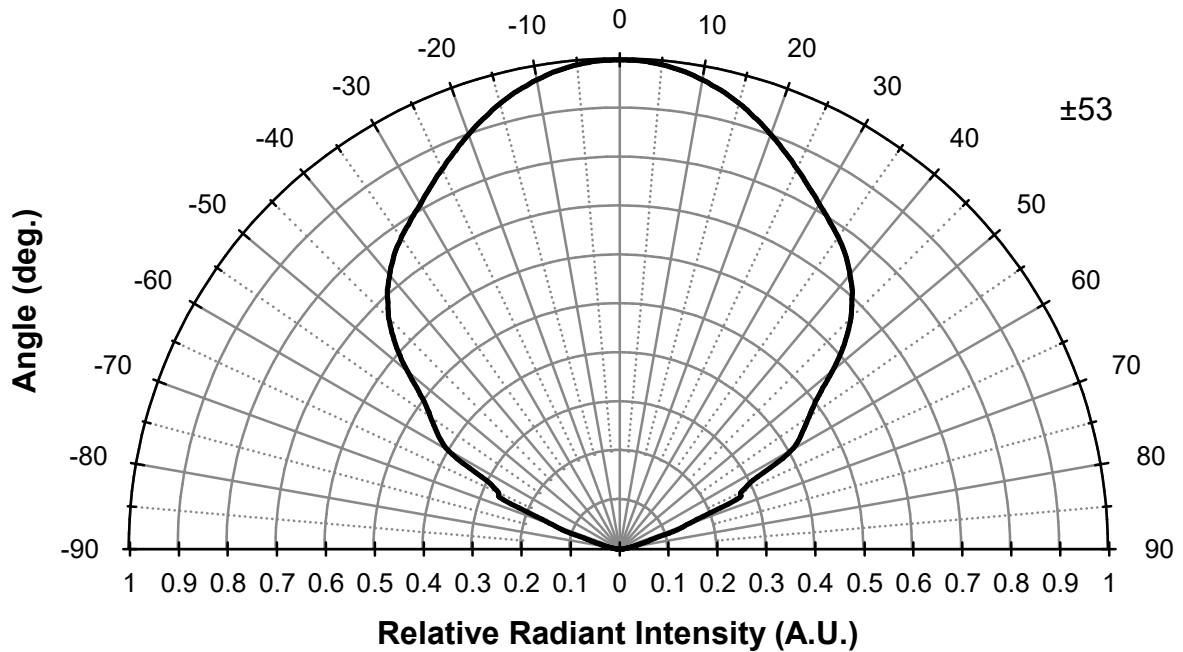

\*The data below shows the characteristics of one representative TO-66 chip.

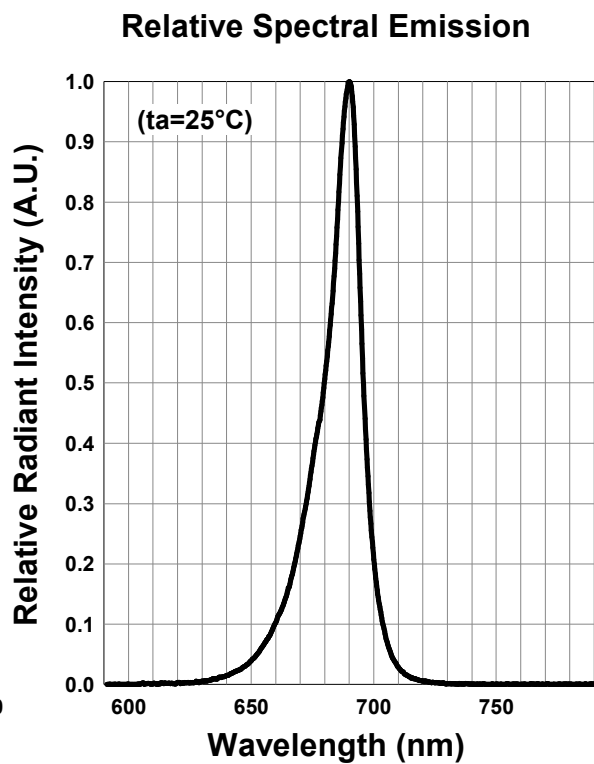
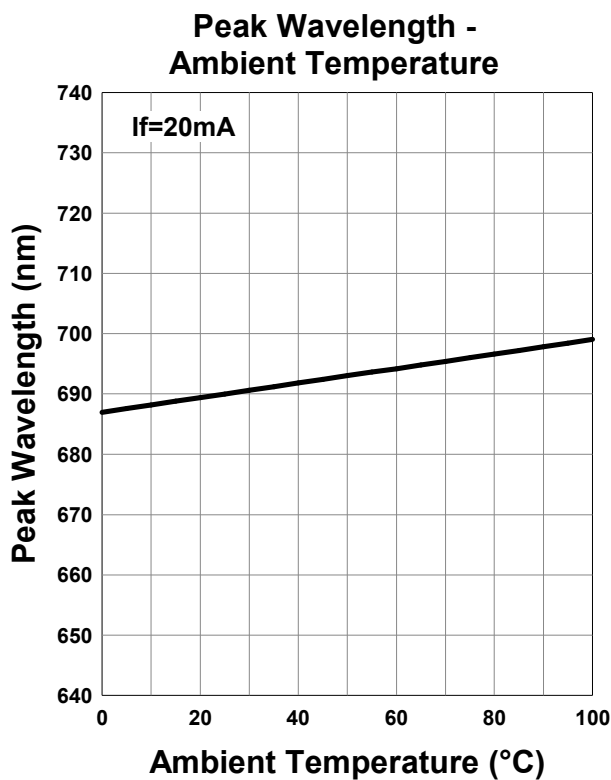
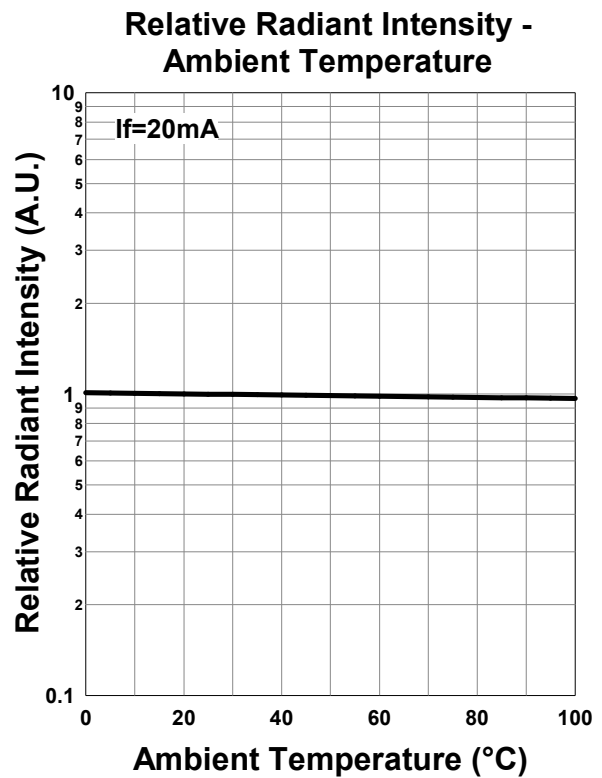
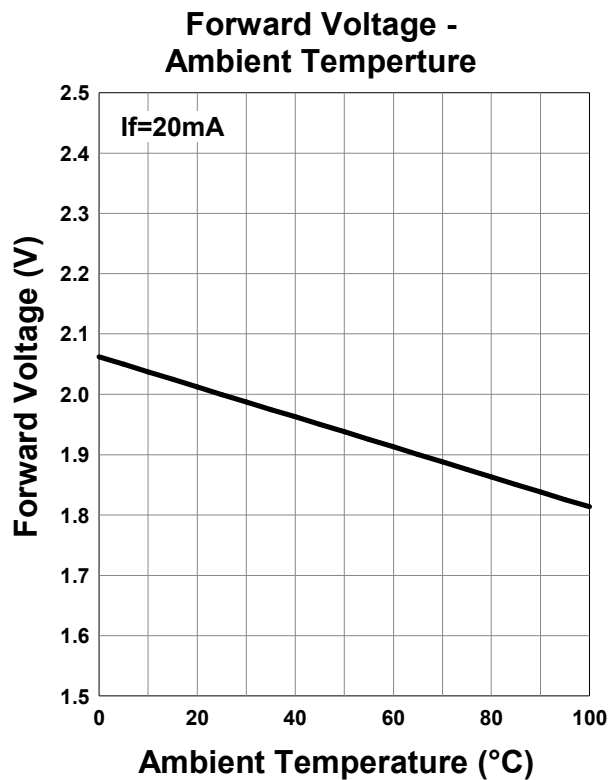

## Disclaimer

Product specifications and data shown in this product catalog are subject to change without notice for the purposes of improving product performance, reliability, design, or otherwise.

Product data and parameters in this catalog are typical values based on reasonably up-to-date measurements.

Product data and parameters may vary by user application and over time.

Products shown in this catalog are intended to be used for general electronic equipment. Products are not guaranteed for applications where product malfunction or failure may cause personal injury or death, including but not limited to life-supporting / saving devices, medical devices, safety devices, airplanes, aerospace equipment, automobiles, traffic control systems, and nuclear reactor control systems.

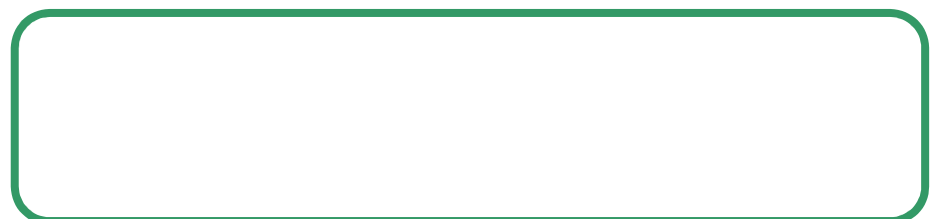

\*Effective July 2016, Ushio Epitex Inc. is now USHIO OPTO SEMICONDUCTORS, INC.