

**epitex****PRELIMINARY**

## L980D-66-60

Infrared illuminator

### Outline and Internal Circuit

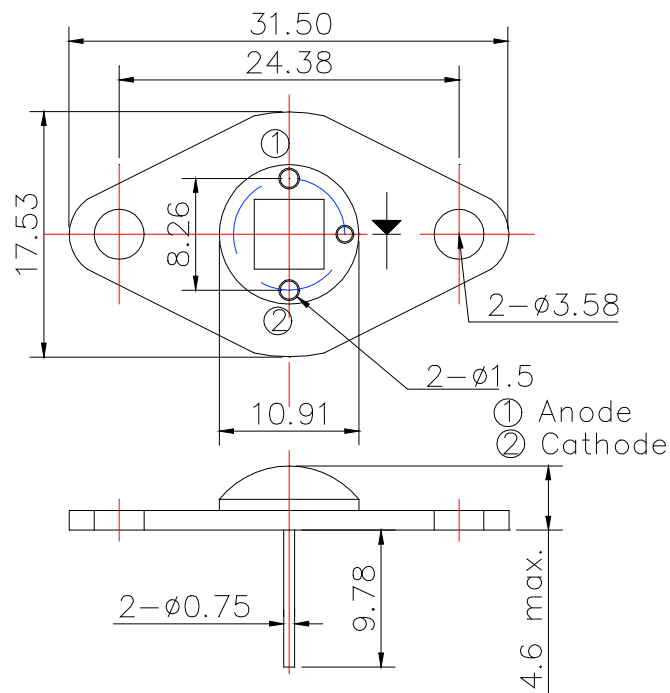

(Unit : mm)

### Features

- Chip Material : AlGaAs
- Chip Dimension : 350um \* 350um
- Number of Chips : 60pcs
- Peak Wavelength : 980nm typ.
- Stem : TO-66 stem
- Lens : Silicone and/or Epoxy resin

### Application

**Absolute Maximum Ratings (Tc=25°C)**

Item	Symbol	Ratings	Unit
Power Dissipation	PD	11	W
Forward Current	IF	1200	mA
Reverse Voltage	VR	25	V
Thermal Resistance	Rthjs	2	K/W
Junction Temperature	Tj	120	°C
Operating Temperature	Topr	-40 ~ +85	°C
Storage Temperature	Tstg	-40 ~ +100	°C
Soldering Temperature	TSOL	265	°C

‡Soldering condition : Soldering condition must be completed with 3 seconds at 265°C.

**Optical and Electrical Characteristics (Tc=25°C)**

(\*: 100% testing, \*\*: reference value)

Parameter	Symbol	Min	Typ	Max	Unit	Test Condition
Forward Voltage	VF		7.5	9.0	V	IF=600mA**
Reverse Current	IR			10	uA	VR=5V**
Total Radiated Power	PO		1000		mW	IF=600mA**
Peak Wavelength	$\lambda_p$	970		990	nm	IF=100mA*
Half Width	$\Delta\lambda$		55		nm	IF=100mA**
Viewing Half Angle	$\theta_{1/2}$		$\pm 64$		deg.	IF=100mA**
Rise Time	tr		15		ns	IF=600mA**
Fall Time	tf		15		ns	IF=600mA**

‡ Radiated Power is measured by S3584-08.

## Typical Characteristic Curves

### Forward Current - Forward Voltage

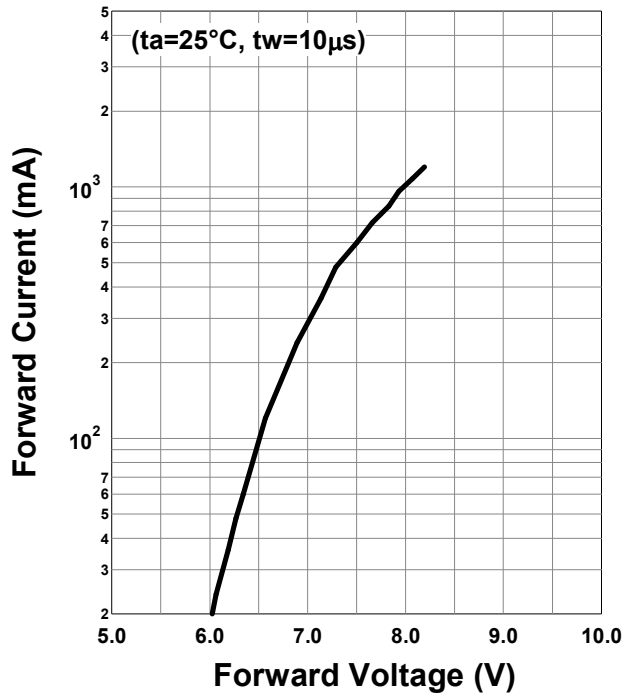

### Relative Radiant Intensity - Forward Current

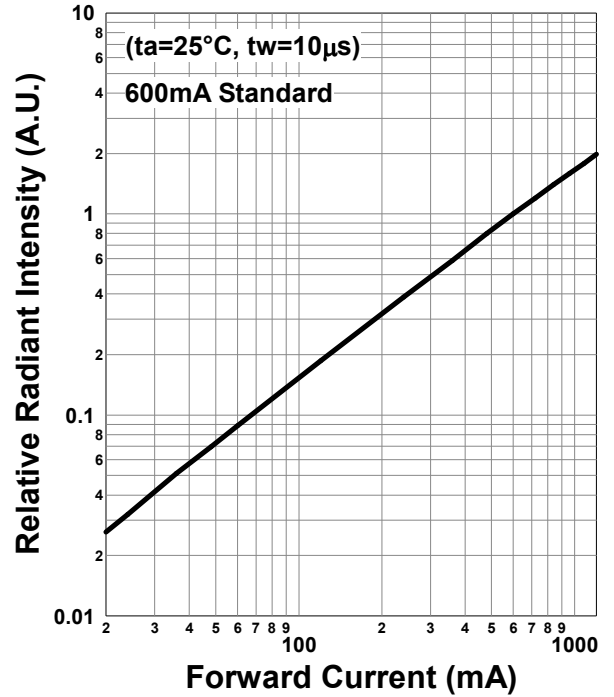

### Allowable Forward Current - Ambient Temperature

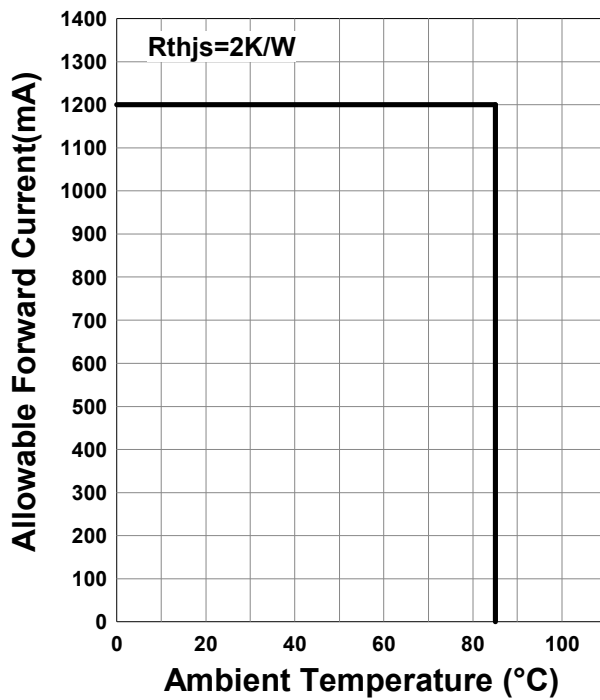

Radiation Characteristics

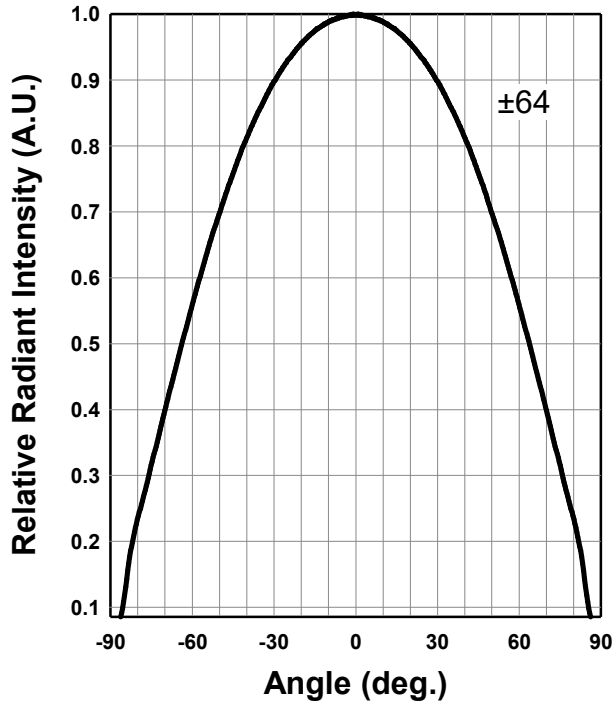

Radiation Characteristics

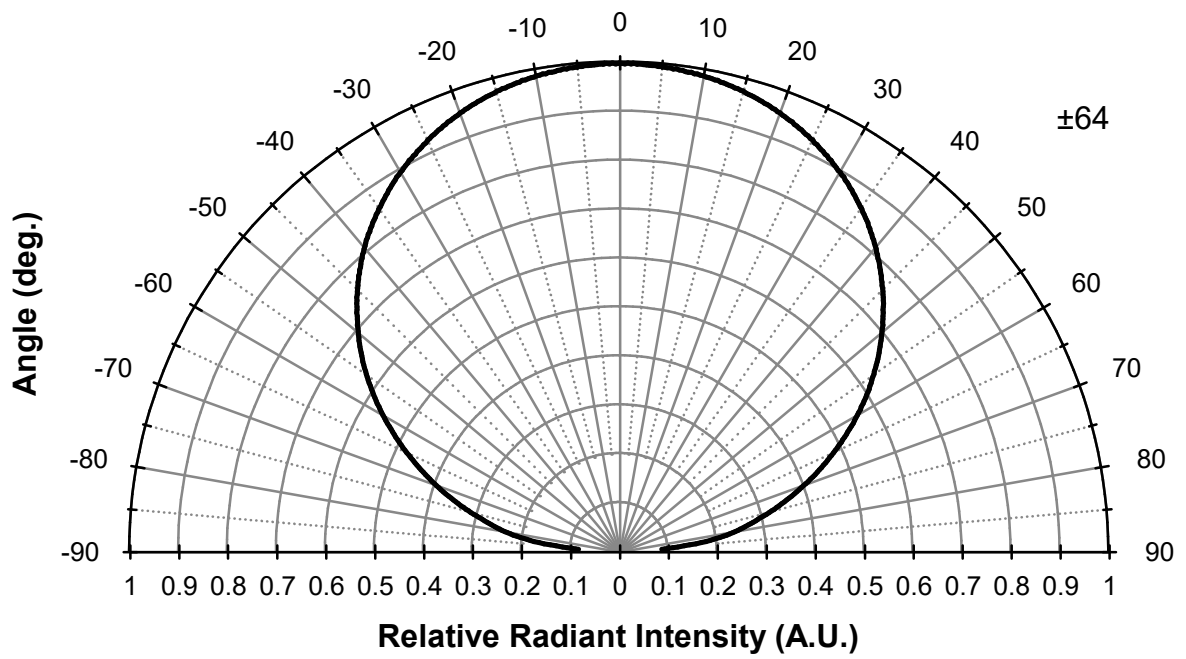

\*The data below shows the characteristics of one representative TO-66 chip.

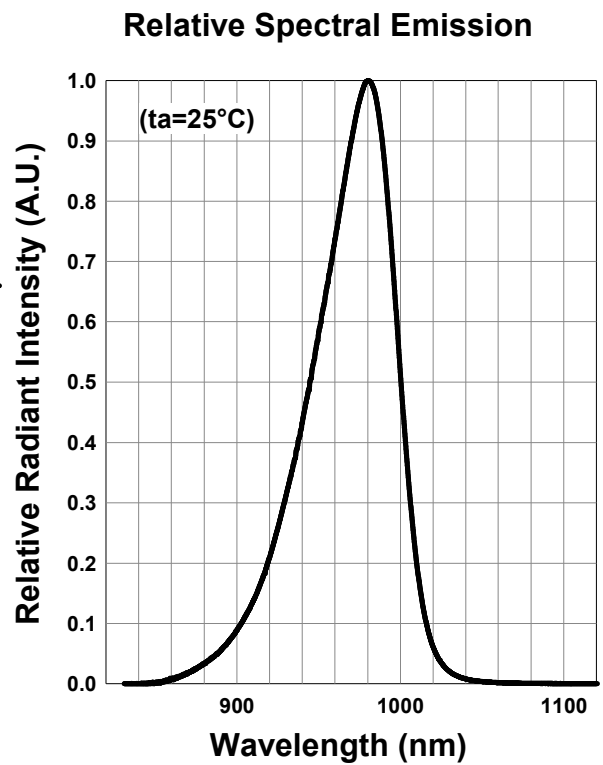
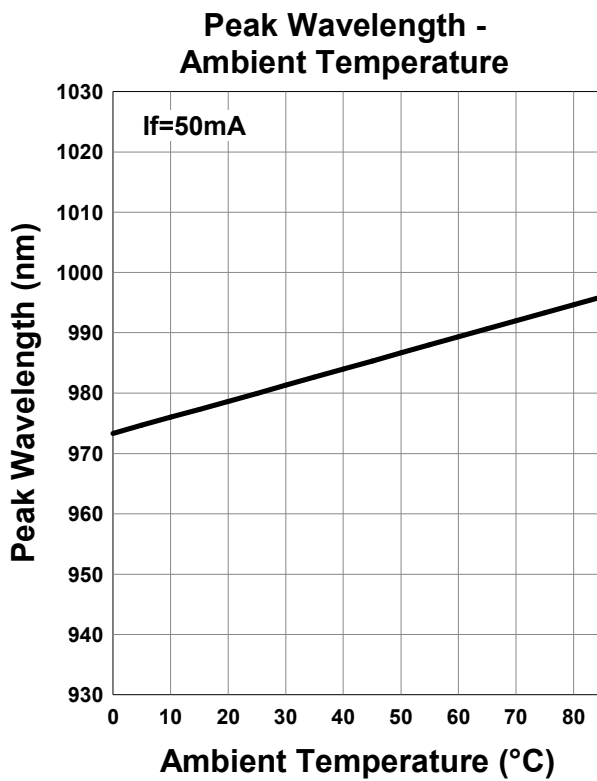
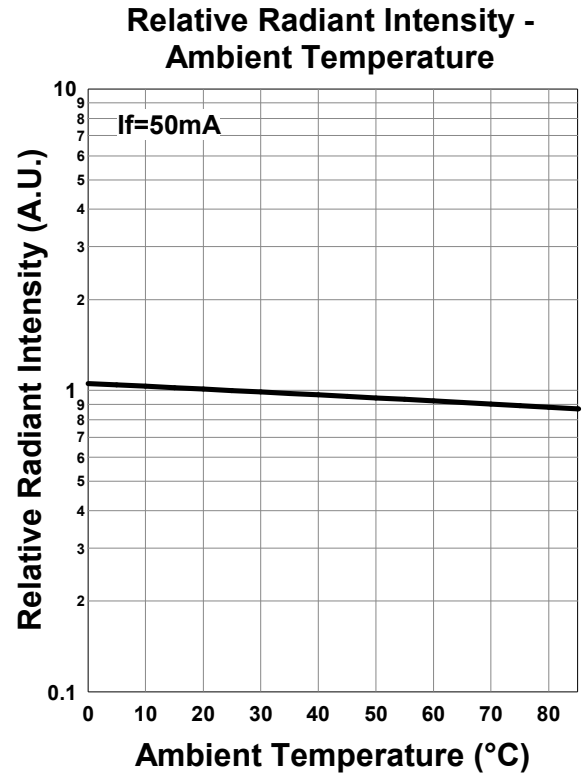
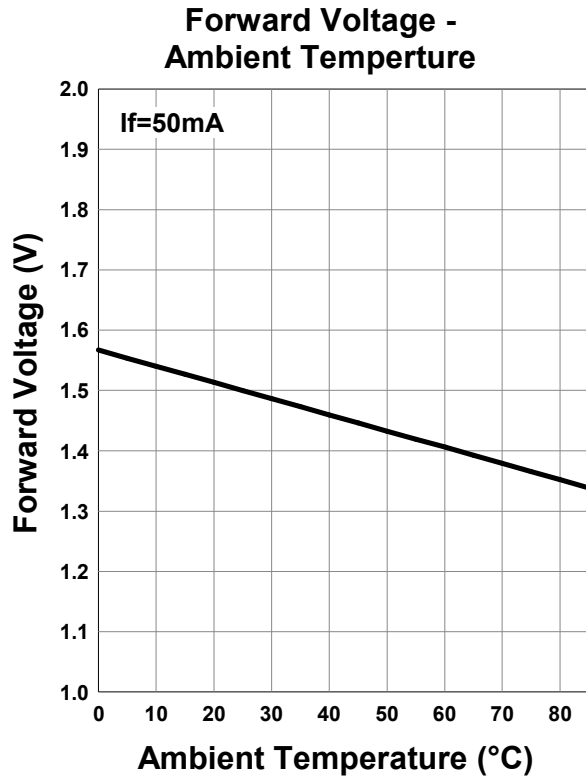

## Disclaimer

Product specifications and data shown in this product catalog are subject to change without notice for the purposes of improving product performance, reliability, design, or otherwise.

Product data and parameters in this catalog are typical values based on reasonably up-to-date measurements.

Product data and parameters may vary by user application and over time.

Products shown in this catalog are intended to be used for general electronic equipment. Products are not guaranteed for applications where product malfunction or failure may cause personal injury or death, including but not limited to life-supporting / saving devices, medical devices, safety devices, airplanes, aerospace equipment, automobiles, traffic control systems, and nuclear reactor control systems.