

# Data Sheet

## SMC405

405nm High Performance SMD LED on ceramics

USHIO

### Outline and Internal Circuit

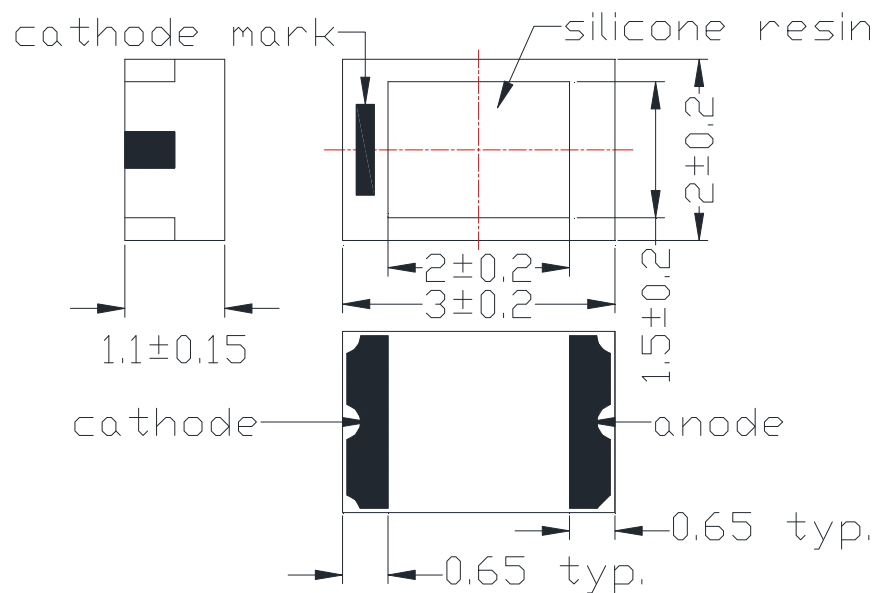

(Unit : mm)

### Features

- Chip Material : InGaN
- Chip Dimension : 350um\*350um
- Number of Chips : 1pce
- Peak Wavelength : 405nm typ.
- Lead Frame Die : Ceramics
- Lens : Silicone resin

### Application

## Absolute Maximum Ratings (Tc=25°C)

Item	Symbol	Ratings	Unit
Power Dissipation	PD	200	mW
Forward Current	IF	50	mA
Pulse Forward Current	IFP	100	mA
Reverse Voltage	VR	5	V
Thermal Resistance	Rthja	80	K/W
Junction Temperature	Tj	120	°C
Operating Temperature	Topr	-40 ~ +100	°C
Storage Temperature	Tstg	-40 ~ +100	°C
Soldering Temperature	TSOL	250	°C

‡Pulse Forward Current condition : Duty 1% and Pulse Width=10us.

‡Soldering condition : Soldering condition must be completed with 5 seconds at 250°C.

## Optical and Electrical Characteristics (Tc=25°C)

Parameter	Symbol	Min	Typ	Max	Unit	Test Condition
Forward Voltage	VF		3.3	4.0	V	IF=20mA
	VFP		3.9			IFP=100mA
Total Radiated Power	PO		15		mW	IF=20mA
			58			IFP=100mA
Radiant Intensity	IE		8.3		mW/sr	IF=20mA
			32			IFP=100mA
Peak Wavelength	$\lambda_p$	400		410	nm	IF=20mA
Half Width	$\Delta\lambda$		19		nm	IF=20mA
Viewing Half Angle	$\theta_{1/2}$		±61		deg.	IF=20mA
Rise Time	tr		10		ns	IF=20mA
Fall Time	tf		15		ns	IF=20mA

‡ Radiated Power is measured by S3584-08.

‡ Radiant Intensity is measured by CIE127-2007 Condition B.

## Typical Characteristic Curves

### Forward Current - Forward Voltage

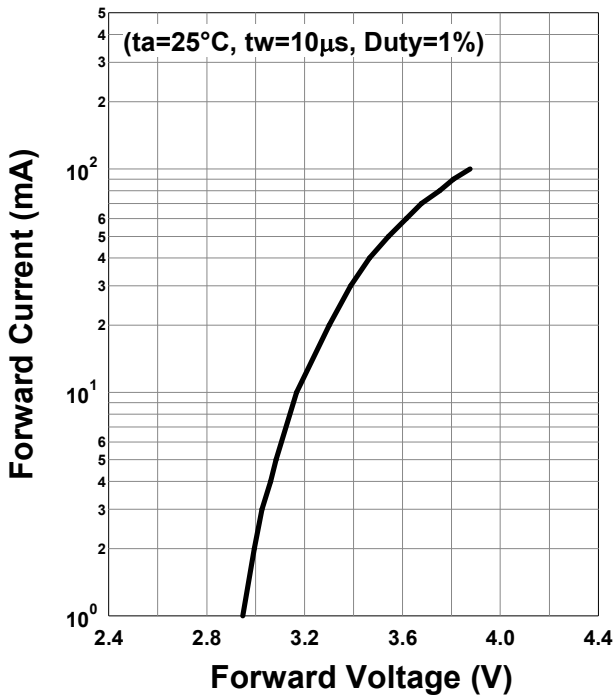

### Relative Radiant Intensity - Forward Current

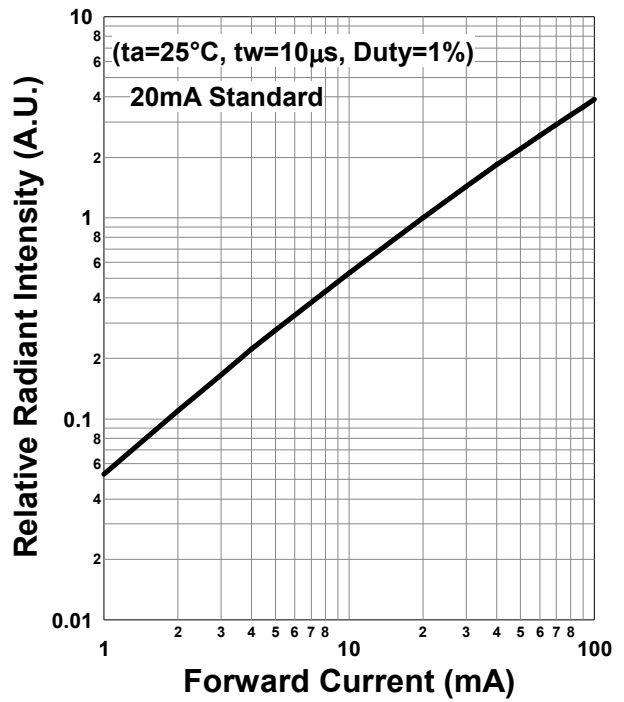

### Forward Current - Pulse Duration

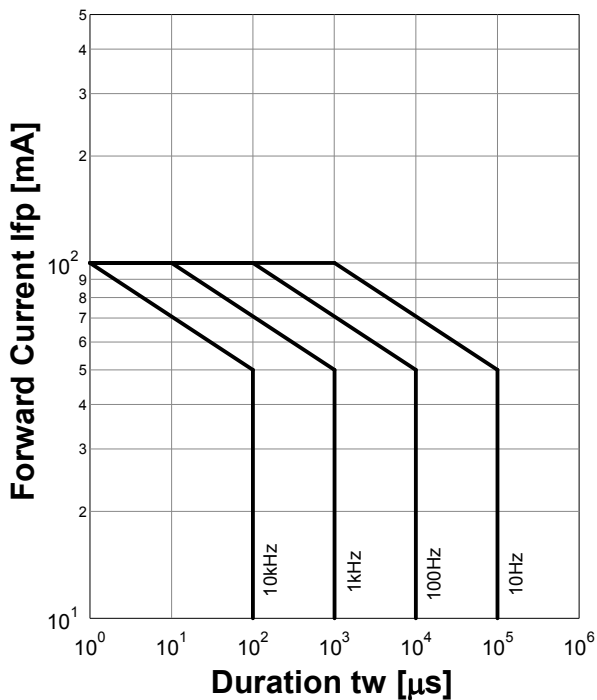

### Allowable Forward Current - Ambient Temperature

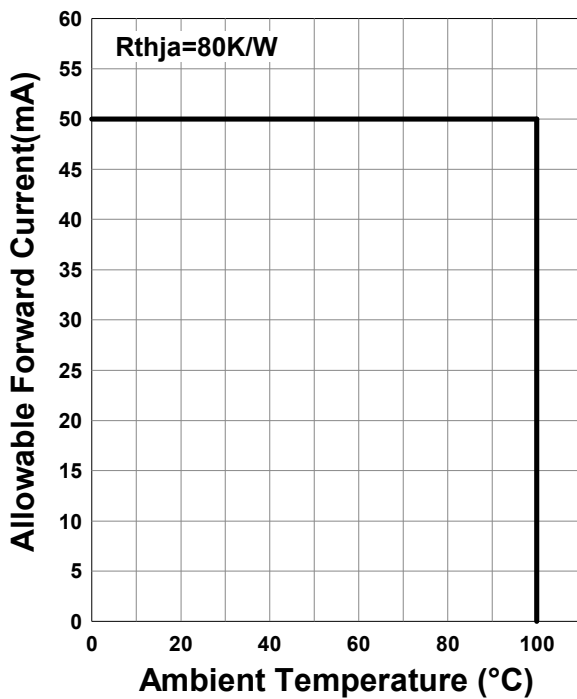

Data Sheet SMC405

**Forward Voltage - Ambient Temperature**

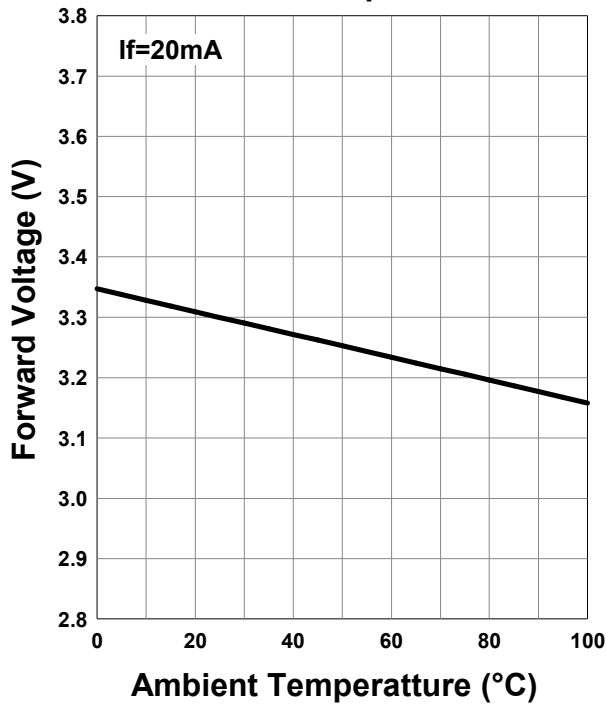

**Relative Radiant Intensity - Ambient Temperature**

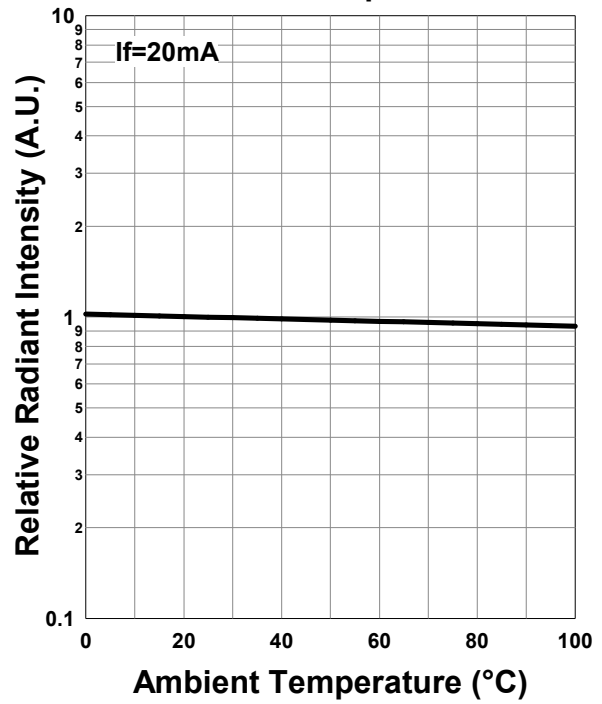

**Peak Wavelength - Ambient Temperature**

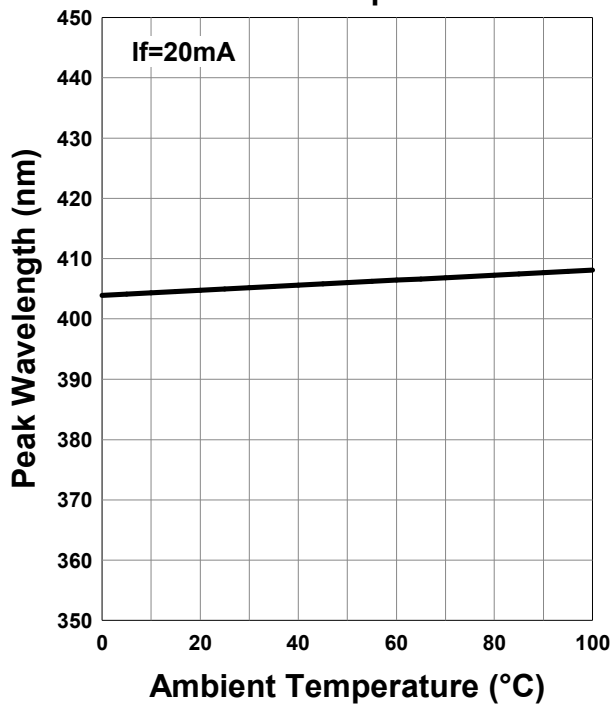

### Relative Spectral Emission

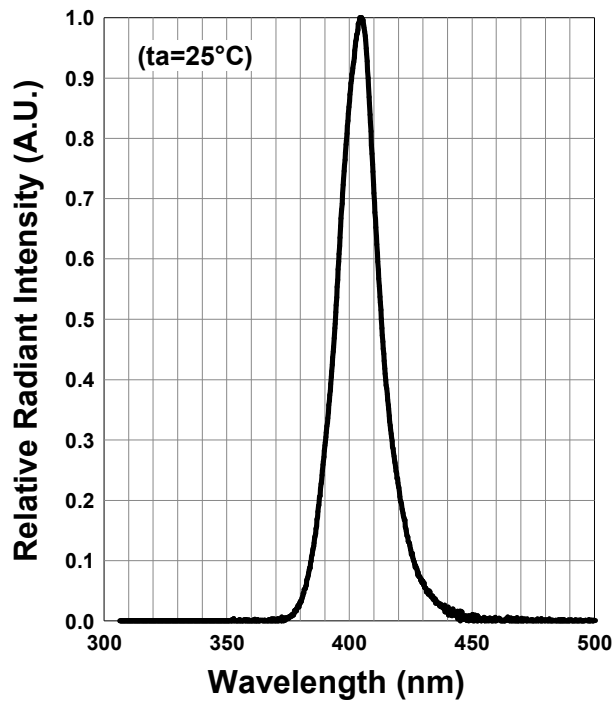

### Radiation Characteristics

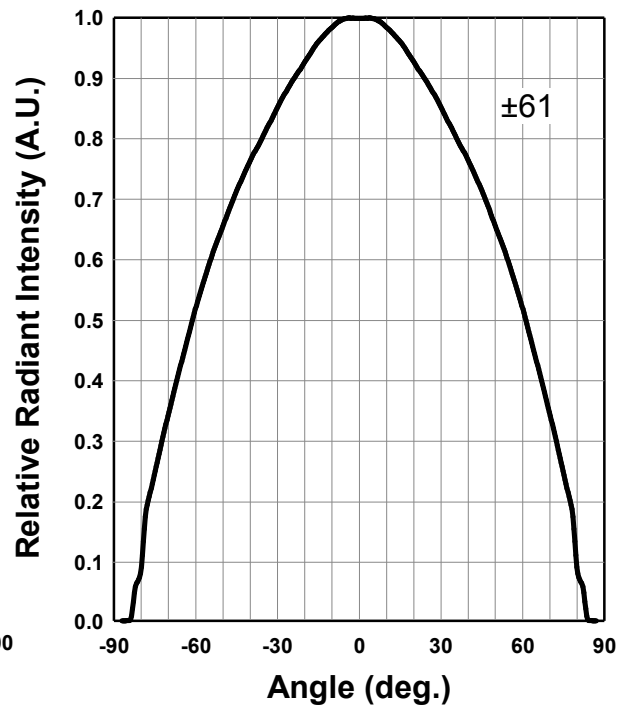

### Radiation Characteristics

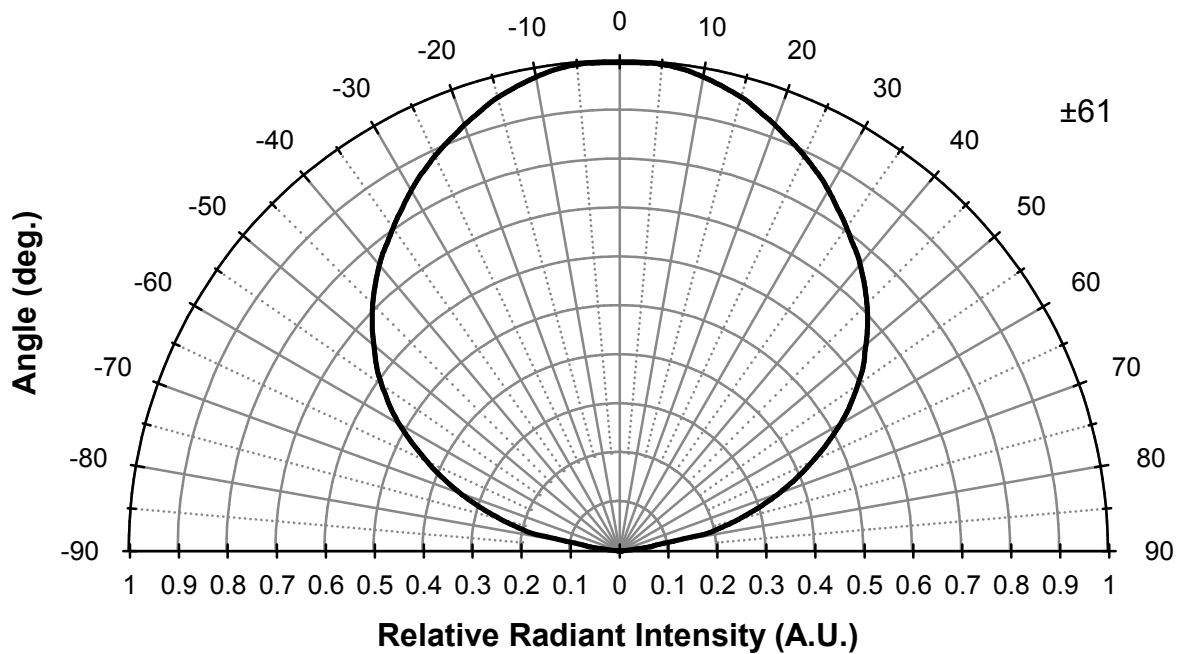

## Wrapping

Moisture barrier bag aluminum laminated film with a desiccant to keep out the moisture absorption during the transportation and storage.

## SMD LED storage and handling precautions

### Storage Conditions before Opening a Moisture-Barrier Aluminum Bag

- Before opening a moisture-barrier aluminum bag, please store it at <30°C, <60%RH.
- Please note that the maximum shelf life is 12 months under these conditions.

### Storage Conditions after Opening a Moisture-Barrier Aluminum Bag

- After opening a moisture-barrier aluminum bag, store the aluminum bag and silica gel in a desiccator.
- After opening the bag, please solder the LEDs within 72 hours in a room with 5 - 30°C, <50%RH.
- Please put any unused, remaining LEDs and silica gel back in the same aluminum bag and then vacuum-seal the bag.
- It is recommended to keep the re-sealed bag in a desiccator at <30%RH.
- The 72-hour- long floor life does not include the time while LEDs are stored in the moisture-barrier aluminum bag. However, we strongly recommend to solder the LEDs as soon as possible after opening the aluminum bag

### Notes about Re-sealing a Moisture-Barrier Aluminum Bag

- When vacuum-sealing an opened aluminum bag, if you find the moisture-indicator of the silica gel has changed to pink from blue (indicating a relative humidity of 30 % or more), please do not use the unused LEDs, the aluminum bag, or the silica gel.

### Notes about Opening a Re-sealed Moisture-Barrier Aluminum Bag

- When opening a vacuumed and re-sealed aluminum bag in order to use the remaining LEDs stored in the bag, if you find that the moisture-indicator of the silica has changed to pink, please do not use the LEDs.

## Disclaimer

Product specifications and data shown in this product catalog are subject to change without notice for the purposes of improving product performance, reliability, design, or otherwise.

Product data and parameters in this catalog are typical values based on reasonably up-to-date measurements.

Product data and parameters may vary by user application and over time.

Products shown in this catalog are intended to be used for general electronic equipment. Products are not guaranteed for applications where product malfunction or failure may cause personal injury or death, including but not limited to life-supporting / saving devices, medical devices, safety devices, airplanes, aerospace equipment, automobiles, traffic control systems, and nuclear reactor control systems.

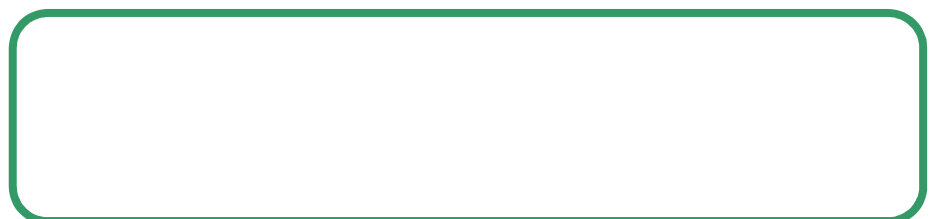

\*Effective July 2016, Ushio Epitex Inc. is now Ushio Opto Semiconductors, Inc.