

epitex

SMT1 150D-22

1 150nm High Performance TOP IR LED

Outline and Internal Circuit

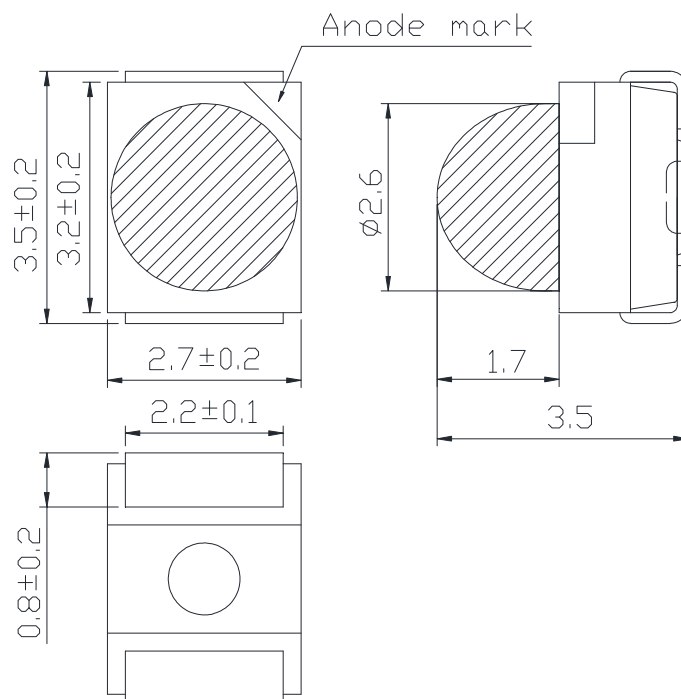

(Unit : mm)

Features

- Chip Material : InGaAsP
- Chip Dimension : 350um * 350um
- Number of Chips : 1pce
- Peak Wavelength : 1150nm typ.
- Lead Frame Die : Silver Plated
- Package Resin : PA6T
- Lens : Silicone or Epoxy Resin

Application

Absolute Maximum Ratings (Tc=25°C)

Item	Symbol	Ratings	Unit
Power Dissipation	PD	150	mW
Forward Current	IF	100	mA
Pulse Forward Current	IFP	1000	mA
Reverse Voltage	VR	5	V
Thermal Resistance	Rthjs	80	K/W
Junction Temperature	Tj	120	°C
Operating Temperature	Topr	-40 ~ +100	°C
Storage Temperature	Tstg	-40 ~ +100	°C
Soldering Temperature	TSOL	250	°C

‡Pulse Forward Current condition : Duty 1% and Pulse Width=10us.

‡Soldering condition : Refer to technical support information on the website.

Optical and Electrical Characteristics (Tc=25°C)

(*: 100% testing, **: reference value)

Parameter	Symbol	Min	Typ	Max	Unit	Test Condition
Forward Voltage	VF		1.2	1.5	V	IF=50mA*
	VFP		3.0			IFP=1A**
Reverse Current	IR			10	uA	VR=5V*
Total Radiated Power	PO	10	15		mW	IF=50mA*
			75			IFP=1A**
Radiant Intensity	IE		50		mW/sr	IF=50mA**
			250			IFP=1A**
Peak Wavelength	λ_p	1120		1180	nm	IF=50mA*
Half Width	$\Delta\lambda$		65		nm	IF=50mA**
Viewing Half Angle	$\theta_{1/2}$		±15		deg.	IF=50mA**
Rise Time	tr		60		ns	IF=50mA**
Fall Time	tf		30		ns	IF=50mA**

‡ Radiated Power is measured by G8370-85.

‡ Radiant Intensity is measured by ANDO Optical Multi Meter AQ2140 & AQ2743.

Typical Characteristic Curves

Forward Current - Forward Voltage

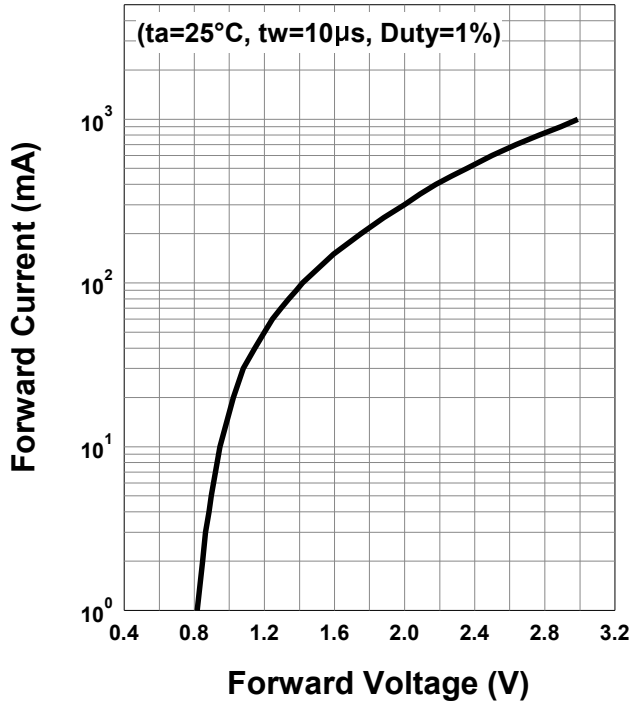

Relative Radiant Intensity - Forward Current

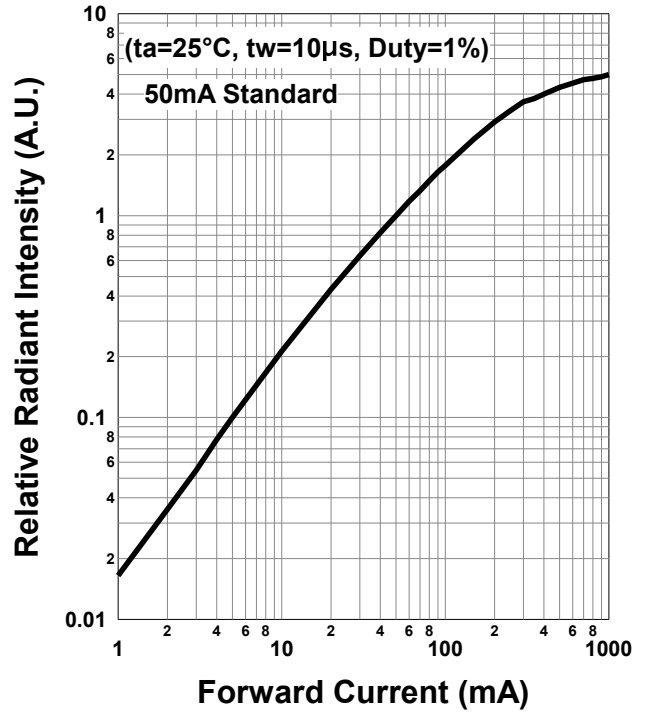

Forward Current - Pulse Duration

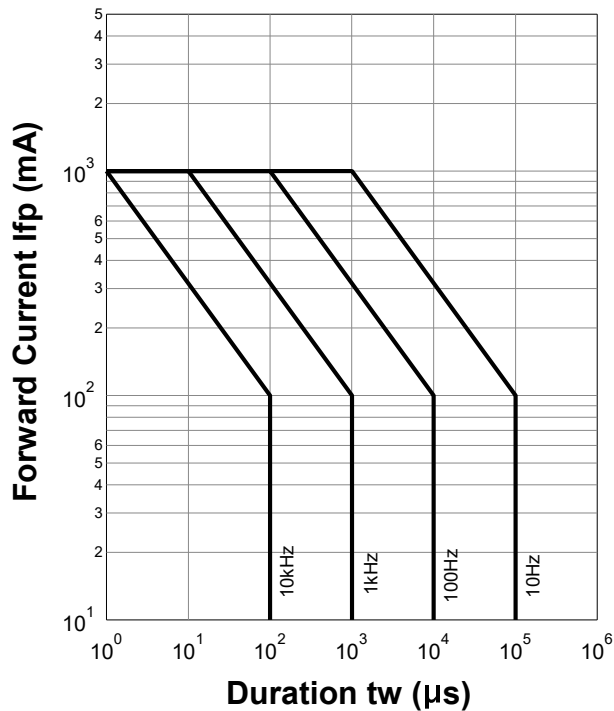

Allowable Forward Current - Ambient Temperature

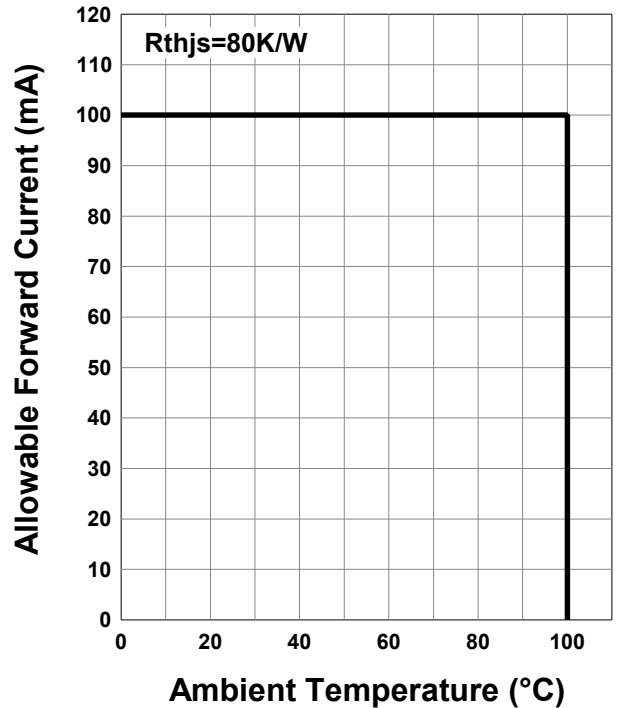

Forward Voltage - Ambient Temperature

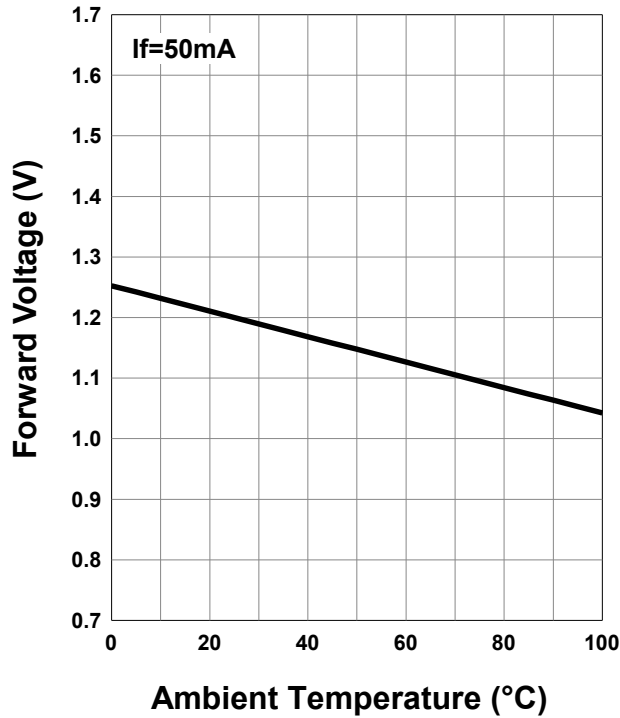

Relative Radiant Intensity - Ambient Temperature

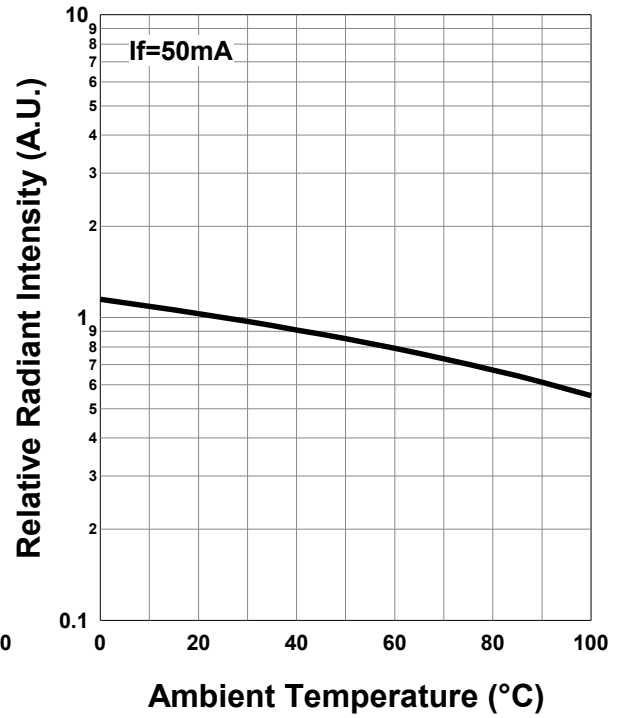

Peak Wavelength - Ambient Temperature

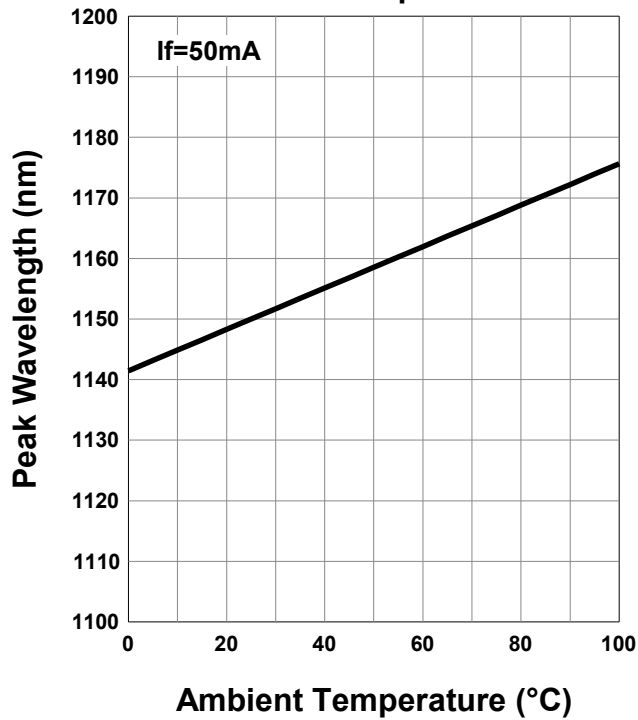

Relative Spectral Emission

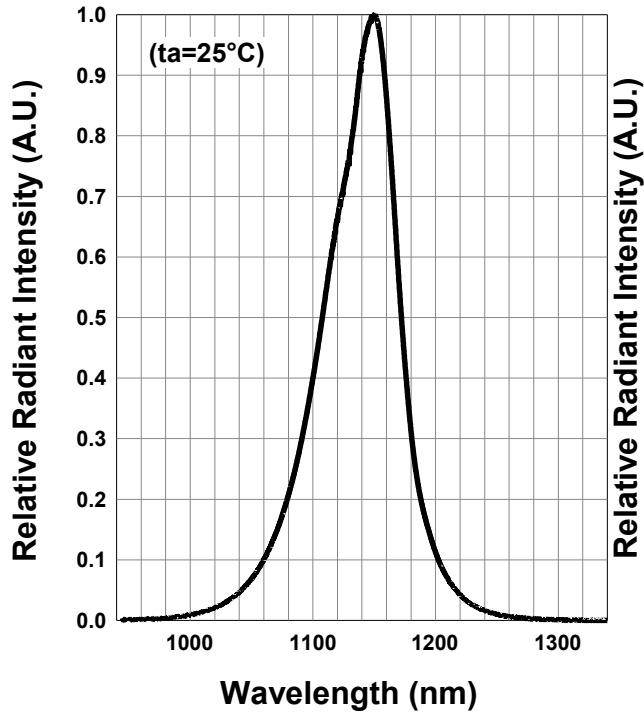

Radiation Characteristics

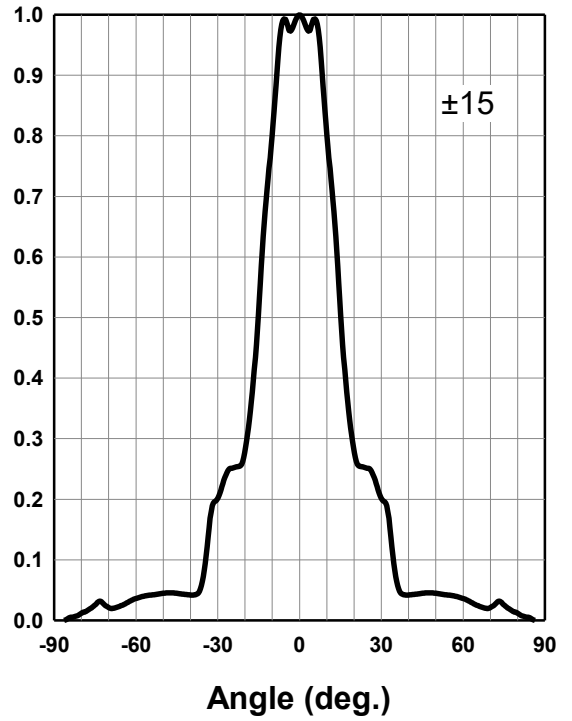

Radiation Characteristics

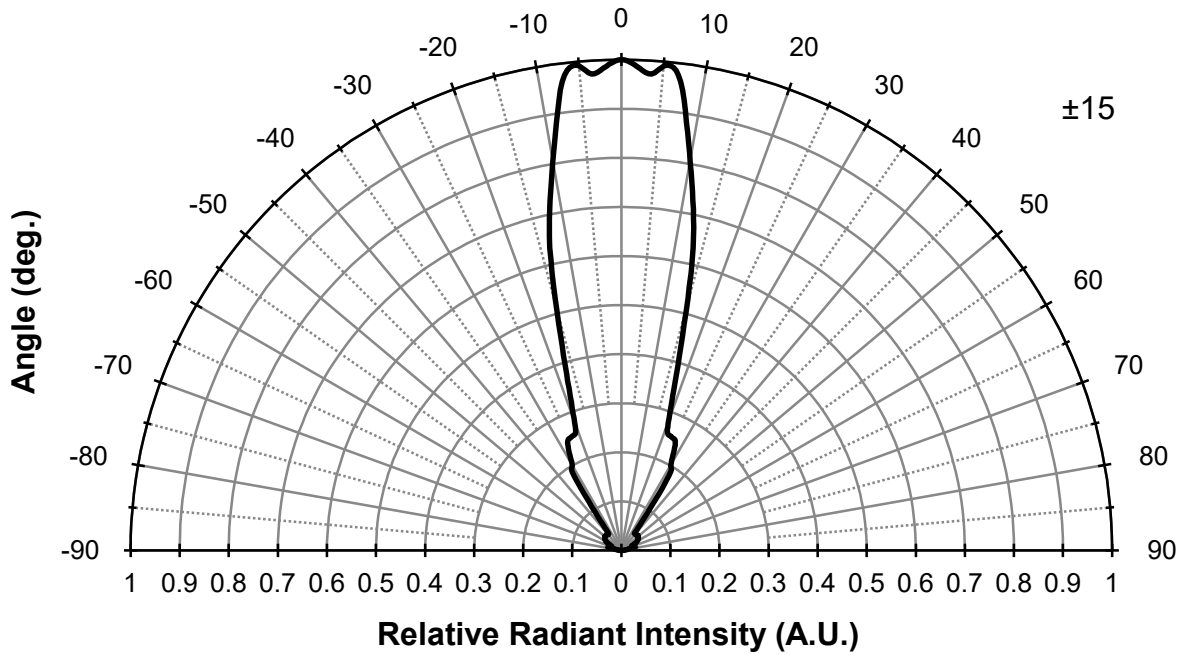

Wrapping

Moisture barrier bag aluminum laminated film with a desiccant to keep out the moisture absorption during the transportation and storage.

SMD LED storage and handling precautions

Storage Conditions before Opening a Moisture-Barrier Aluminum Bag

- Before opening a moisture-barrier aluminum bag, please store it at <30°C, <60%RH.
- Please note that the maximum shelf life is 12 months under these conditions.

Storage Conditions after Opening a Moisture-Barrier Aluminum Bag

- After opening a moisture-barrier aluminum bag, store the aluminum bag and silica gel in a desiccator.
- After opening the bag, please solder the LEDs within 72 hours in a room with 5 - 30°C, <50%RH.
- Please put any unused, remaining LEDs and silica gel back in the same aluminum bag and then vacuum-seal the bag.
- It is recommended to keep the re-sealed bag in a desiccator at <30%RH.
- The 72-hour- long floor life does not include the time while LEDs are stored in the moisture-barrier aluminum bag. However, we strongly recommend to solder the LEDs as soon as possible after opening the aluminum bag.

Notes about Re-sealing a Moisture-Barrier Aluminum Bag

- When vacuum-sealing an opened aluminum bag, if you find the moisture-indicator of the silica gel has changed to pink from blue (indicating a relative humidity of 30 % or more), please do not use the unused LEDs, the aluminum bag, or the silica gel.

Notes about Opening a Re-sealed Moisture-Barrier Aluminum Bag

- When opening a vacuumed and re-sealed aluminum bag in order to use the remaining LEDs stored in the bag, if you find that the moisture-indicator of the silica has changed to pink, please do not use the LEDs.

Disclaimer

Product specifications and data shown in this product catalog are subject to change without notice for the purposes of improving product performance, reliability, design, or otherwise.

Product data and parameters in this catalog are typical values based on reasonably up-to-date measurements.

Product data and parameters may vary by user application and over time.

Products shown in this catalog are intended to be used for general electronic equipment. Products are not guaranteed for applications where product malfunction or failure may cause personal injury or death, including but not limited to life-supporting / saving devices, medical devices, safety devices, airplanes, aerospace equipment, automobiles, traffic control systems, and nuclear reactor control systems.

Technical Support Information

<https://www.ushio.co.jp/en/led/technology/index.html>



USHIO