

## epitex

### SMT880D

880nm High Performance TOP IR LED

#### Outline and Internal Circuit

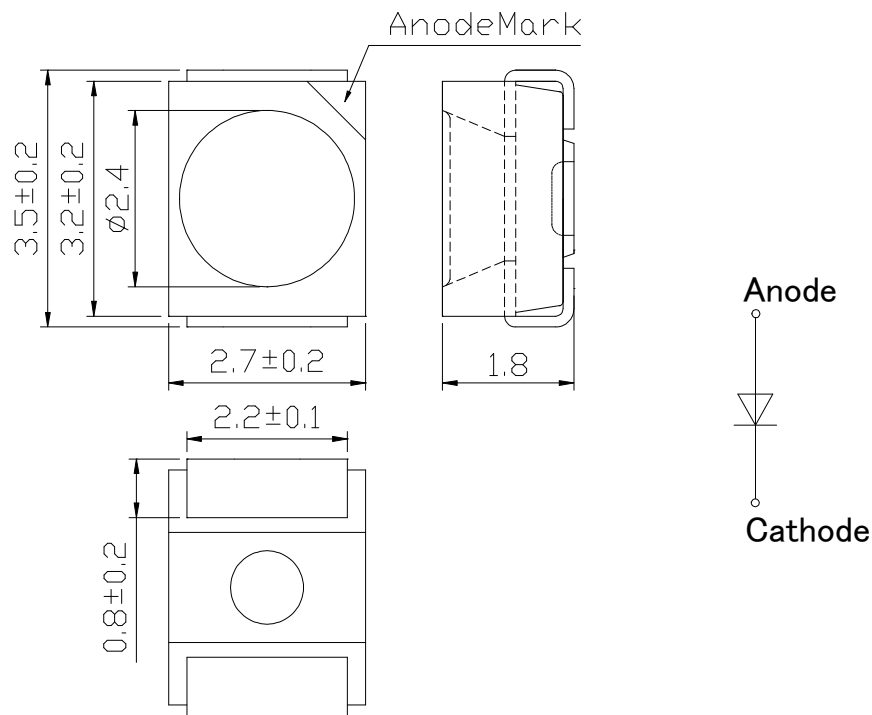

(Unit : mm)

#### Features

- Chip Material : AlGaAs
- Chip Dimension : 350um \* 350um
- Number of Chips : 1pce
- Peak Wavelength : 880nm typ.
- Lead Frame Die : Silver Plated
- Package Resin : Polyamide Resin
- Lens : Silicone or Epoxy Resin

#### Application

## Absolute Maximum Ratings (Tc=25°C)

Item	Symbol	Ratings	Unit
Power Dissipation	PD	200	mW
Forward Current	IF	100	mA
Pulse Forward Current	IFP	1000	mA
Reverse Voltage	VR	5	V
Thermal Resistance	Rthjs	80	K/W
Junction Temperature	Tj	120	°C
Operating Temperature	Topr	-40 ~ +100	°C
Storage Temperature	Tstg	-40 ~ +100	°C
Soldering Temperature	TSOL	250	°C

‡Pulse Forward Current condition : Duty 1% and Pulse Width=10us.

‡Soldering condition : Refer to technical support information on the website.

## Optical and Electrical Characteristics (Tc=25°C)

(\*: 100% testing, \*\*: reference value)

Parameter	Symbol	Min	Typ	Max	Unit	Test Condition
Forward Voltage	VF		1.5	2.0	V	IF=50mA*
			2.8			IFP=1A**
Reverse Current	IR			10	uA	VR=5V*
Total Radiated Power	PO	19	28		mW	IF=50mA*
			460			IFP=1A**
Radiant Intensity	IE		11		mW/sr	IF=50mA**
			170			IFP=1A**
Peak Wavelength	$\lambda_p$	870		890	nm	IF=50mA*
Half Width	$\Delta\lambda$		33		nm	IF=50mA**
Viewing Half Angle	$\theta_{1/2}$		±61		deg.	IF=50mA**
Rise Time	tr		15		ns	IF=50mA**
Fall Time	tf		20		ns	IF=50mA**

‡ Radiated Power is measured by S3584-08.

‡ Radiant Intensity is measured by CIE127-2007 Condition B.

## Typical Characteristic Curves

### Forward Current - Forward Voltage

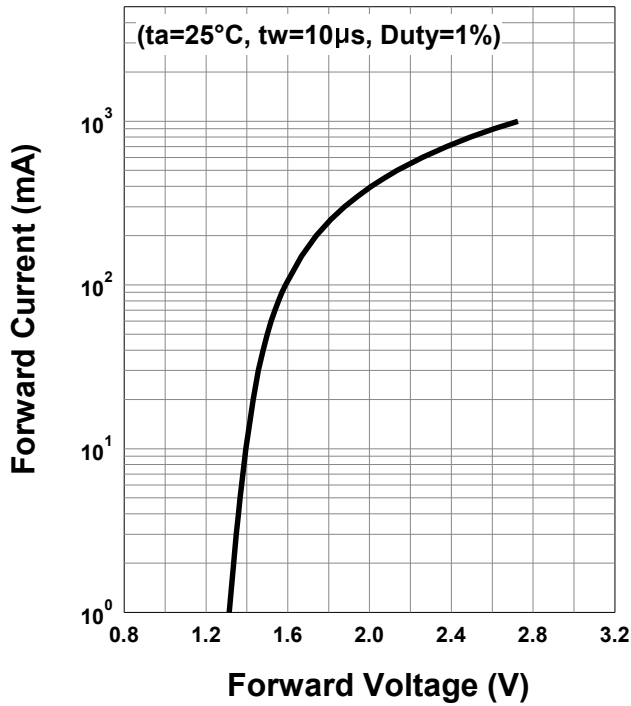

### Relative Radiant Intensity - Forward Current

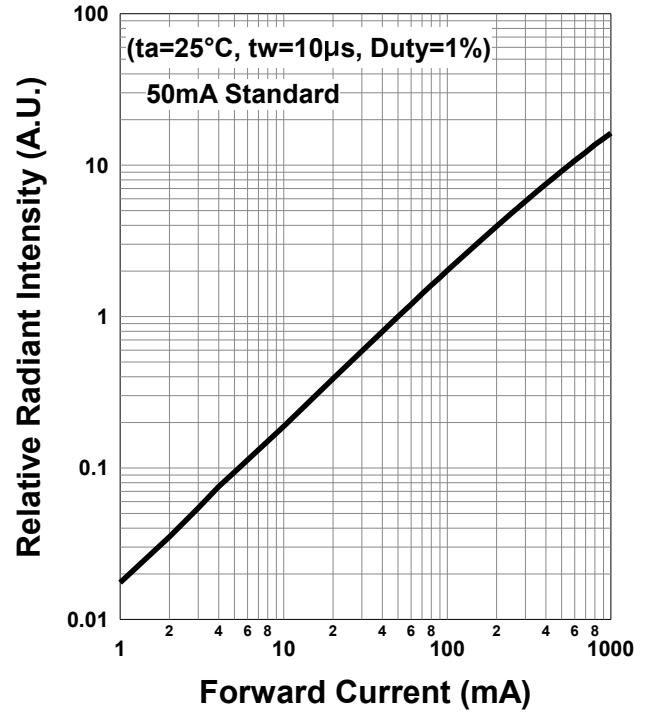

### Forward Current - Pulse Duration

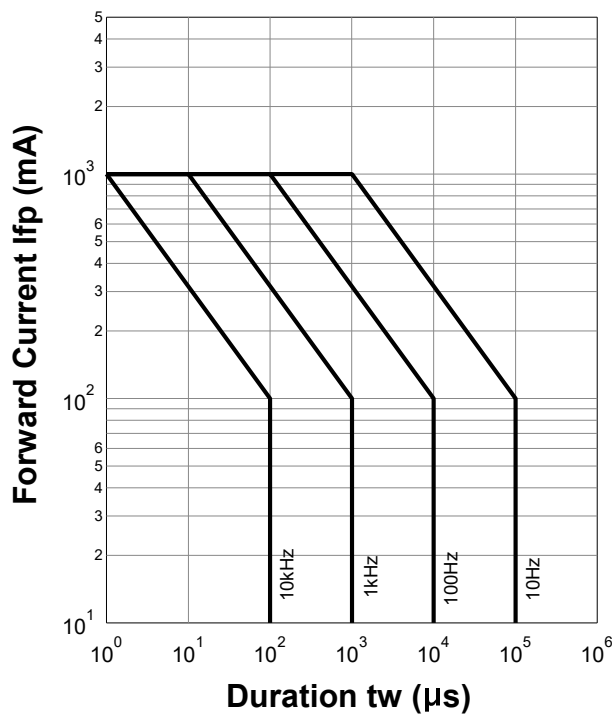

### Allowable Forward Current - Ambient Temperature

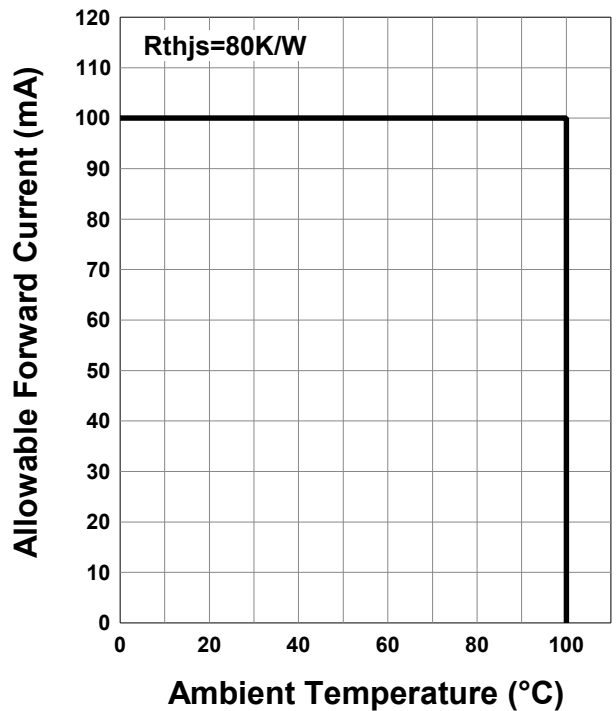

**Forward Voltage - Ambient Temperature**

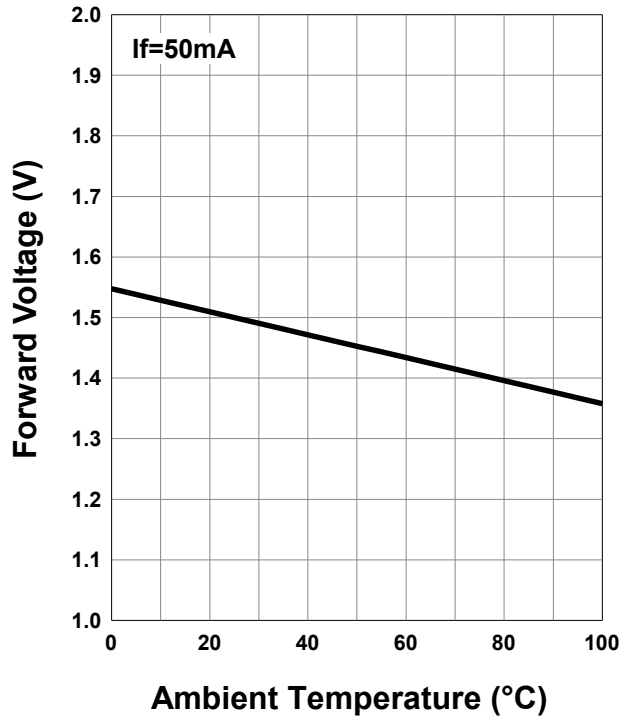

**Relative Radiant Intensity - Ambient Temperature**

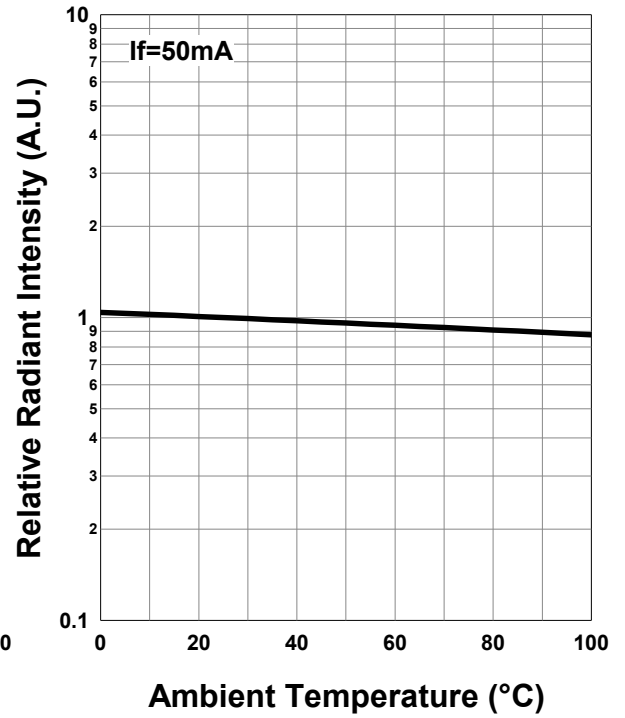

**Peak Wavelength - Ambient Temperature**

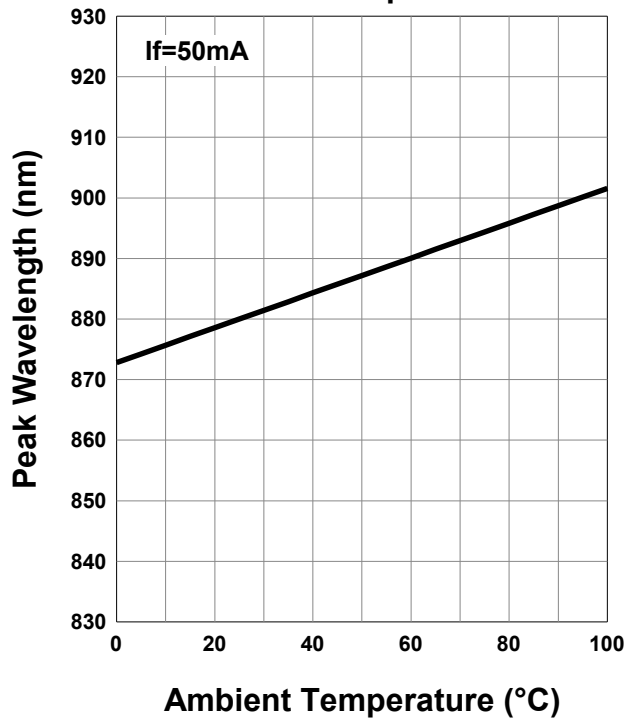

Relative Spectral Emission

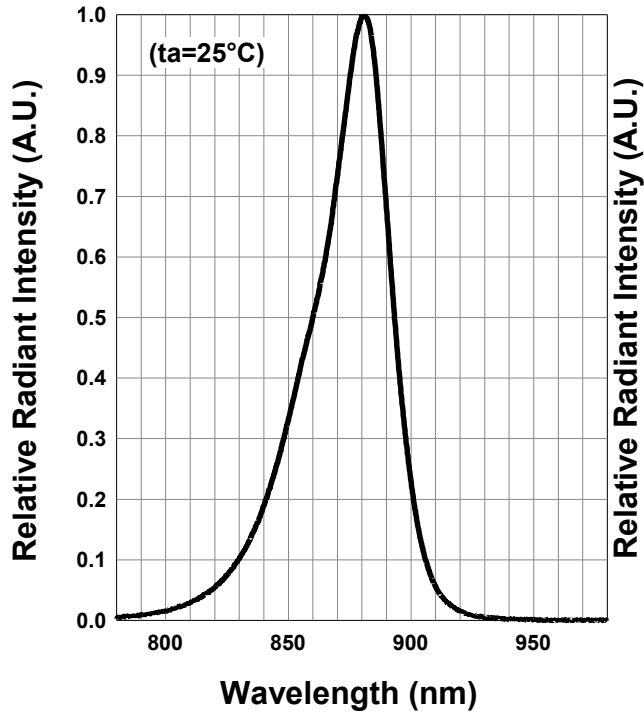

Radiation Characteristics

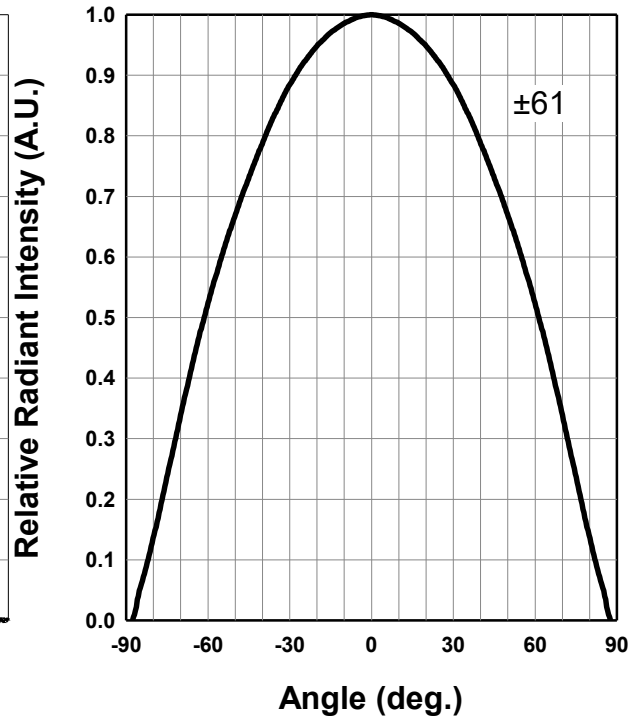

Radiation Characteristics

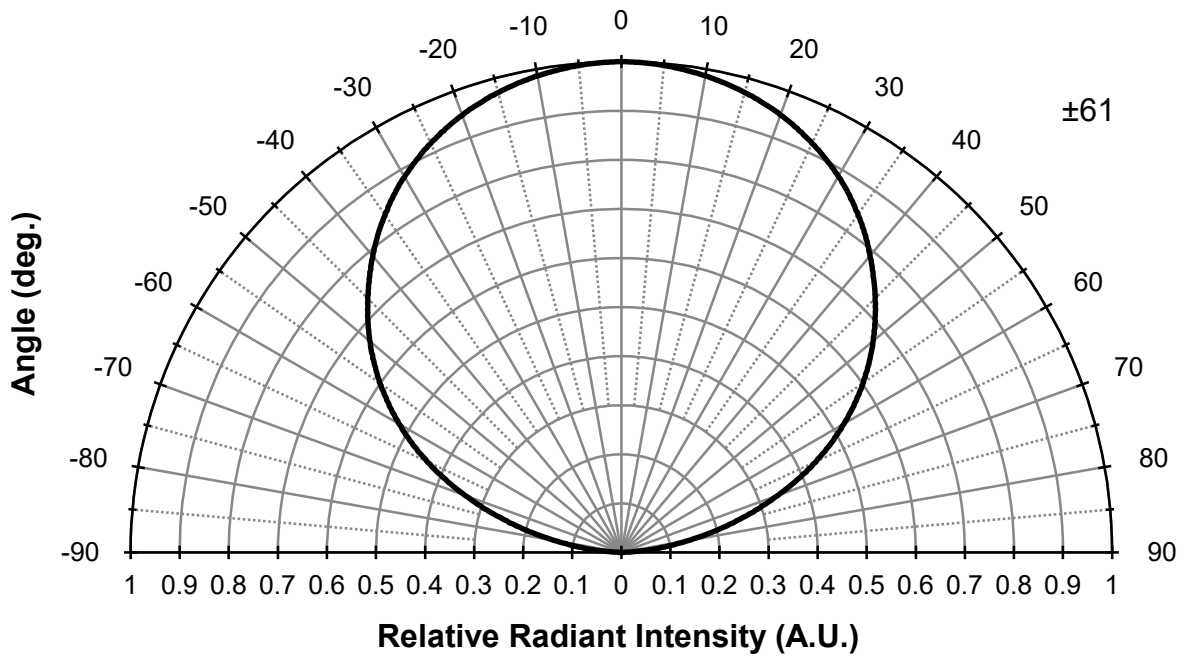

## Wrapping

Moisture barrier bag aluminum laminated film with a desiccant to keep out the moisture absorption during the transportation and storage.

## SMD LED storage and handling precautions

### Storage Conditions before Opening a Moisture-Barrier Aluminum Bag

- Before opening a moisture-barrier aluminum bag, please store it at <30°C, <60%RH.
- Please note that the maximum shelf life is 12 months under these conditions.

### Storage Conditions after Opening a Moisture-Barrier Aluminum Bag

- After opening a moisture-barrier aluminum bag, store the aluminum bag and silica gel in a desiccator.
- After opening the bag, please solder the LEDs within 72 hours in a room with 5 - 30°C, <50%RH.
- Please put any unused, remaining LEDs and silica gel back in the same aluminum bag and then vacuum-seal the bag.
- It is recommended to keep the re-sealed bag in a desiccator at <30%RH.
- The 72-hour- long floor life does not include the time while LEDs are stored in the moisture-barrier aluminum bag. However, we strongly recommend to solder the LEDs as soon as possible after opening the aluminum bag.

### Notes about Re-sealing a Moisture-Barrier Aluminum Bag

- When vacuum-sealing an opened aluminum bag, if you find the moisture-indicator of the silica gel has changed to pink from blue (indicating a relative humidity of 30 % or more), please do not use the unused LEDs, the aluminum bag, or the silica gel.

### Notes about Opening a Re-sealed Moisture-Barrier Aluminum Bag

- When opening a vacuumed and re-sealed aluminum bag in order to use the remaining LEDs stored in the bag, if you find that the moisture-indicator of the silica has changed to pink, please do not use the LEDs.

## Disclaimer

Product specifications and data shown in this product catalog are subject to change without notice for the purposes of improving product performance, reliability, design, or otherwise.

Product data and parameters in this catalog are typical values based on reasonably up-to-date measurements.

Product data and parameters may vary by user application and over time.

Products shown in this catalog are intended to be used for general electronic equipment. Products are not guaranteed for applications where product malfunction or failure may cause personal injury or death, including but not limited to life-supporting / saving devices, medical devices, safety devices, airplanes, aerospace equipment, automobiles, traffic control systems, and nuclear reactor control systems.

## Technical Support Information

<https://www.ushio.co.jp/en/led/technology/index.html>



# USHIO