



Xenon Lamps for Sharp NEC Display Solutions Digital Cinema Projector

DXL-12SN

Technical Data

Input Power	W	-	1200	
Voltage	V	-	20	
Current	A	-	60	
Lamp Length	mm	a	306	
LCL	mm	b	144	
Cold Arc Gap	mm	c	4.5	
Cathode	Base Diameter	mm (Φ)	d	27
	Pin Diameter	mm (Φ)	e	20
	Pin Length	mm	f	19
Anode	Base Diameter	mm (Φ)	g	27
	Pin Diameter	mm (Φ)	h	14
	Pin Length	mm	i	13
Bulb diameter	mm (Φ)	j	45	
Cable length	mm	k	(160)	
Crimping terminal	mm	l	22-10	

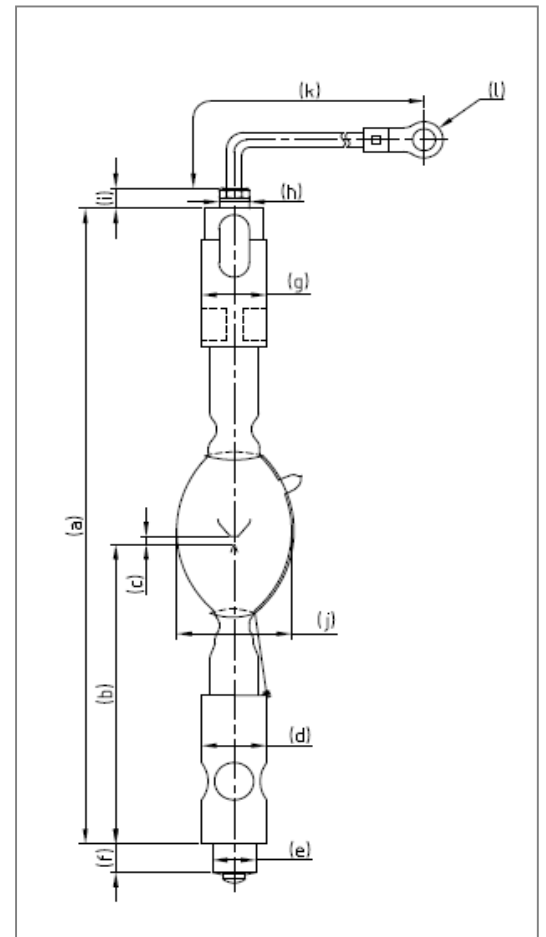

Warranty Hours

DXL-12SN	3000
----------	------

Cross Reference

Lamp Type	Projector Model
DXL-12SN	NC1200C NC2000C